

4

3

2

1

BODINE ELECTRIC COMPANY

PART NO./REV: INFM0289 A	
DESCRIPTION: MOTOR 34B6BEBL	
SHEET: 1/1	UNLESS OTHERWISE SPECIFIED:
SCALE: 1:4	UNITS ARE IN INCHES [mm]
B	TOLERANCES: .XX:±.01 .XXX:±.005
	ANGLES: X°:±3° X.X°:±0.5°

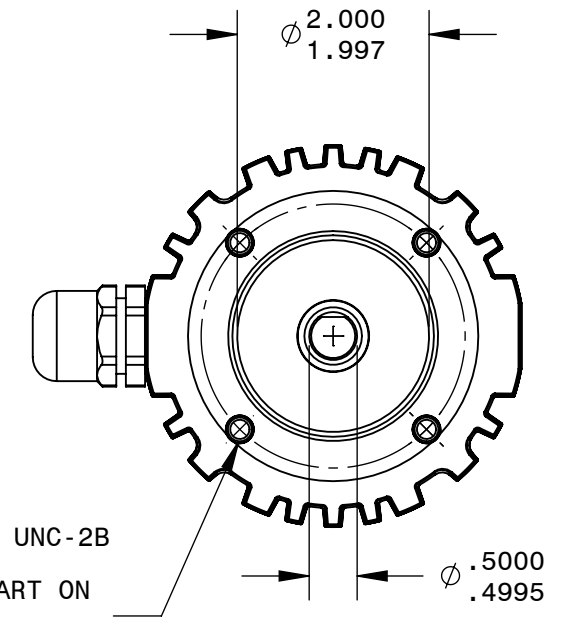
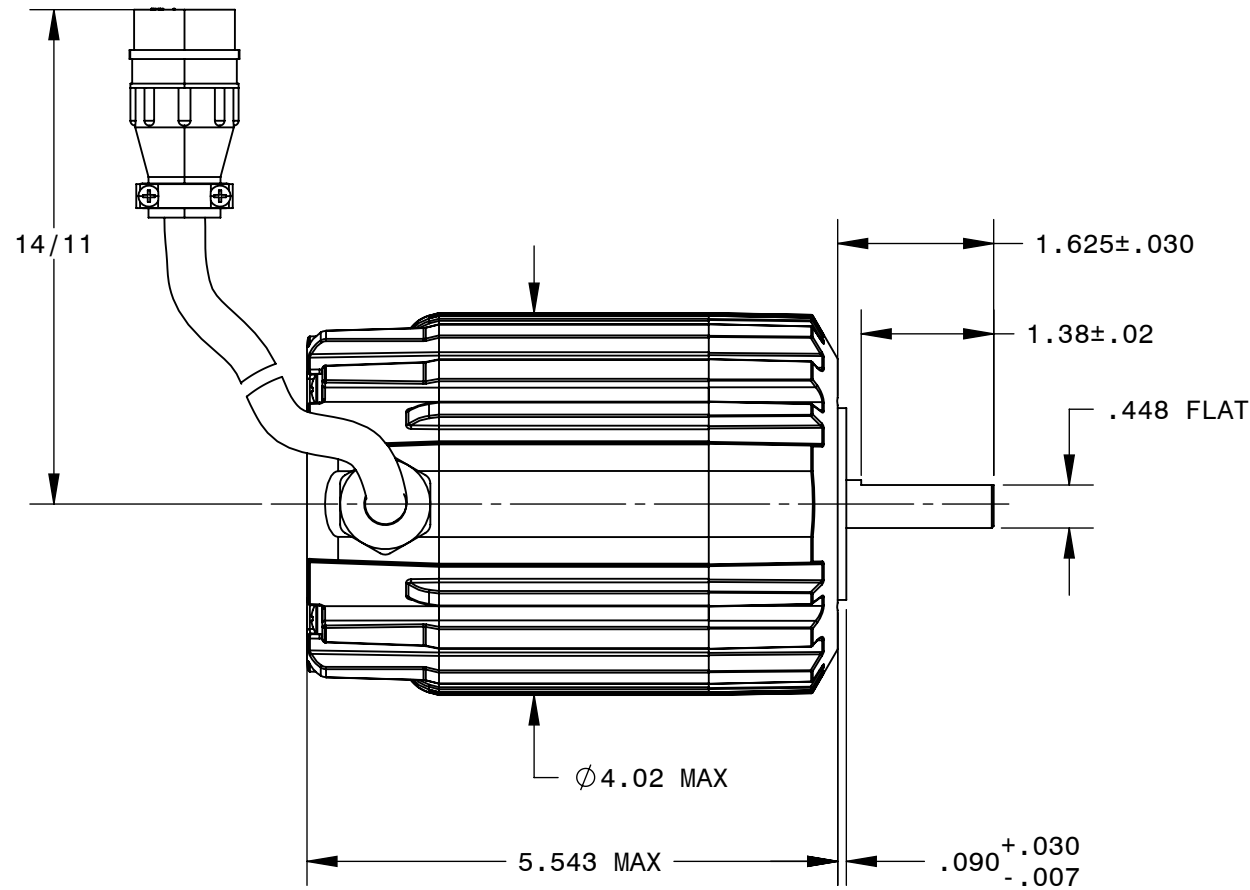
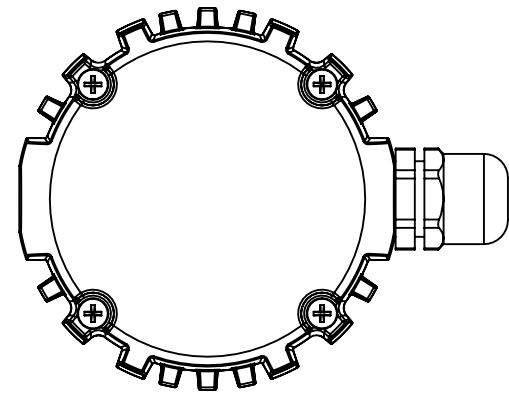
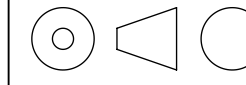

REPRESENTATIVE OF MODEL NUMBER(S):
3309

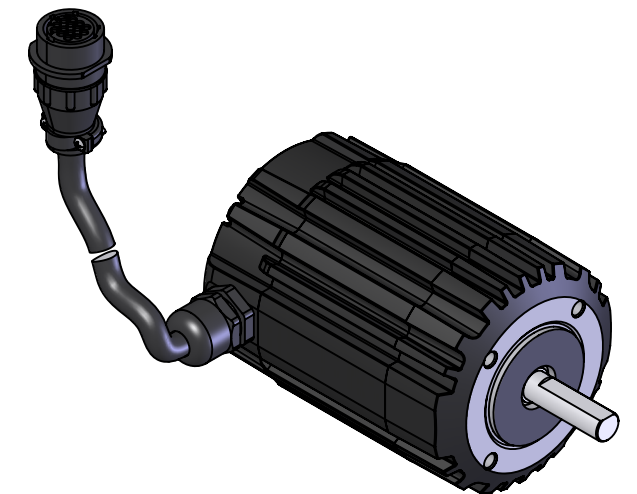

4

3

2

1